

# Compressivi girevoli Serie 50 ML nelle varie tipologie di: Fissaggi, Ruote assemblati Swivel castors of the 50 ML series with different types of fixings, assembled wheels

Requisiti dei Compressivi assemblati alle varie Ruote  
Requirements of the castors assembled with the different wheels

\* Gli articoli evidenziati in colore verde sono in fase di allestimento.  
\* Articles written in green colour are in course of preparation.

Portata Dinamica conforme UNI EN 12527  
Dynamic load capacity conform UNI EN 12527



Portata Statica conforme UNI EN 12527

Static load capacity conform UNI EN 12527



		B8	B10	F	S	PI	P7 68.5x48	E
 = Peso per 1 pezzo = Weight for a piece								
50G	ITEM	50/ML/GB8	50/ML/GB10	50/ML/GF	50/ML/GS	50/ML/GPI	50/ML/GP7	50/ML/GE
	D	30	30	30	30	30	30	30
	S	45	45	45	45	45	45	45
		187	187	212	217	223	220	236
code			4851	4866		4856		
50Gd	ITEM	50/ML/GdB8	50/ML/GdB10	50/ML/GdF	50/ML/GdS	50/ML/GdPI	50/ML/GdP7	50/ML/GdE
	D	30	30	30	30	30	30	30
	S	45	45	45	45	45	45	45
		192	192	217	222	228	225	241
code			5044			5043		
50Gc	ITEM	50/ML/GcB8	50/ML/GcB10	50/ML/GcF	50/ML/GcS	50/ML/GcPI	50/ML/GcP7	50/ML/GcE
	D	30	30	30	30	30	30	30
	S	45	45	45	45	45	45	45
		216	216	241	246	253	250	265
code			5006			5003		
50SR	ITEM	50/ML/SRB8	50/ML/SRB10	50/ML/SRF	50/ML/SRS	50/ML/SRPI	50/ML/SRP7	50/ML/SRE
	D	-	-	-	-	-	-	-
	S	-	-	-	-	-	-	-
		159	159	184	189	207	204	220
code			5400			5402		
50SRd	ITEM	50/ML/SRdB8	50/ML/SRdB10	50/ML/SRdF	50/ML/SRdS	50/ML/SRdPI	50/ML/SRdP7	50/ML/SRdE
	D	-	-	-	-	-	-	-
	S	-	-	-	-	-	-	-
		-	-	-	-	-	-	-
code								
50N	ITEM	50/ML/NB8	50/ML/NB10	50/ML/NF	50/ML/NS	50/ML/NPI	50/ML/NP7	50/ML/NE
	D	54	54	54	54	54	54	54
	S	81	81	81	81	81	81	81
		150	150	175	180	188	185	199
code			5025			5034		
50Nd	ITEM	50/ML/NdB8	50/ML/NdB10	50/ML/NdF	50/ML/NdS	50/ML/NdPI	50/ML/NdP7	50/ML/NdE
	D	54	54	54	54	54	54	54
	S	81	81	81	81	81	81	81
		199	199	224	229	237	234	248
code			5212			5054		

∅ 50

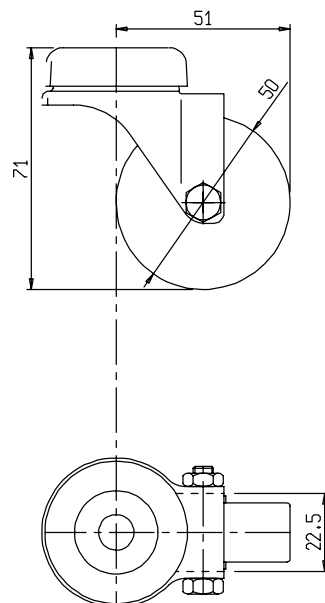

ITEM	50/ML/G-Gd-SR-SRd	ITEM	50/ML/N-Nd	ITEM	50/ML/G-Gd-Gc
	con Asse Rivettato With riveted axle		con Asse a Vite With screw axle		Nucleo Grigio Grey Centre

# Compressivi girevoli Serie 60 ML nelle varie tipologie di: Fissaggi, Ruote assemblati Swivel castors of the 60 ML series with different types of fixings, assembled wheels

Requisiti dei Compressivi assemblati alle varie Ruote  
Requirements of the castors assembled with the different wheels

\* Gli articoli evidenziati in colore verde sono in fase di allestimento.  
\* Articles written in green colour are in course of preparation.

Portata Dinamica conforme UNI EN 12527  
Dynamic load capacity conform UNI EN 12527



Portata Statica conforme UNI EN 12527  
Static load capacity conform UNI EN 12527



		B8	B10	F	S	PI	P7 68.5x48	E
 = Peso per 1 pezzo = Weight for a piece								
60G	ITEM	60/ML/GB8	60/ML/GB10	60/ML/GF	60/ML/GS	60/ML/GPI	60/ML/GP7	60/ML/GE
		31	31	31	31	31	31	31
		46	46	46	46	46	46	46
		199	199	224	229	238	235	248
code			5012			5024		
60N	ITEM	60/ML/NB8	60/ML/NB10	60/ML/NF	60/ML/NS	60/ML/NPI	60/ML/NP7	60/ML/NE
		58	58	58	58	58	58	58
		87	87	87	87	87	87	87
		164	164	189	194	203	200	213
code			5035	5022		5027		
60Nd	ITEM	60/ML/NdB8	60/ML/NdB10	60/ML/NdF	60/ML/NdS	60/ML/NdPI	60/ML/NdP7	60/ML/NdE
		58	58	58	58	58	58	58
		87	87	87	87	87	87	87
		-	186	211	216	225	222	235
code								
60NdRa	ITEM	60/ML/NdRaB8	60/ML/NdRaB10	60/ML/NdRaF	60/ML/NdRaS	60/ML/NdRaPI	60/ML/NdRaP7	60/ML/NdRaE
		58	58	58	58	58	58	58
		87	87	87	87	87	87	87
		-	176	201	206	215	212	225
code								

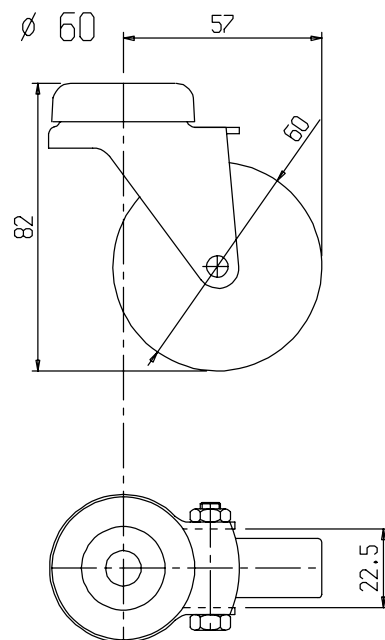



ITEM	60/ML/G	ITEM	60/ML/N-Nd-NdRa	ITEM	60/ML/G
	con Asse Rivettato With riveted axle		con Asse a Vite With screw axle		Nucleo Grigio Grey Centre

# Compressivi girevoli Serie50 MLFT nelle varie tipologie di: Fissaggi, Ruote assemblati Swivel castors of the 50 MLFT series with different types of fixings, assembled wheels











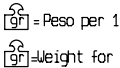



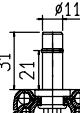

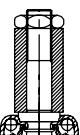























Requisiti dei Compressivi assemblati alle varie Ruote  
Requirements of the castors assembled with the various wheels

\* Gli articoli evidenziati in colore verde sono in fase di allestimento.  
\* Articles written in green colour are in course of preparation.

Portata Dinamica conforme UNI EN 12527  
Dynamic load capacity conform UNI EN 12527 

Portata Statica conforme UNI EN 12527  
Static load capacity conform UNI EN 12527 

Resistenza Passiva del Dispositivo Frenant, conforme UNI EN 12527  
Passive resistance of braking device in compliance UNI EN 12527 

	B8	B10	F	S	PI	P7 68.5x48	E
							
							
							
							
							
							
							
ITEM	50/MLFT/GB8	50/MLFT/GB10	50/MLFT/GF	50/MLFT/GS	50/MLFT/GPI	50/MLFT/GP7	50/MLFT/GE
	30	30	30	30	30	30	30
	45	45	45	45	45	45	45
	-	-	-	-	-	-	-
	223	223	248	253	251	248	272
code	4850				4855		
ITEM	50/MLFT/GdB8	50/MLFT/GdB10	50/MLFT/GdF	50/MLFT/GdS	50/MLFT/GdPI	50/MLFT/GdP7	50/MLFT/GdE
	30	30	30	30	30	30	30
	45	45	45	45	45	45	45
	-	-	-	-	-	-	-
	225	225	250	255	253	250	274
code	5049				5552		
ITEM	50/MLFT/GcB8	50/MLFT/GcB10	50/MLFT/GcF	50/MLFT/GcS	50/MLFT/GcPI	50/MLFT/GcP7	50/MLFT/GcE
	30	30	30	30	30	30	30
	45	45	45	45	45	45	45
	-	-	-	-	-	-	-
	248	248	273	278	276	273	297
code	5007				5004		
ITEM	50/MLFT/SRB8	50/MLFT/SRB10	50/MLFT/SRF	50/MLFT/SRS	50/MLFT/SRPI	50/MLFT/SRP7	50/MLFT/SRE
	-	-	-	-	-	-	-
	-	-	-	-	-	-	-
	-	-	-	-	-	-	-
	200	200	225	230	228	225	249
code							
ITEM	50/MLFT/SRdB8	50/MLFT/SRdB10	50/MLFT/SRdF	50/MLFT/SRdS	50/MLFT/SRdPI	50/MLFT/SRdP7	50/MLFT/SRdE
	-	-	-	-	-	-	-
	-	-	-	-	-	-	-
	-	-	-	-	-	-	-
	-	-	-	-	-	-	-
code							
ITEM	50/MLFT/NB8	50/MLFT/NB10	50/MLFT/NF	50/MLFT/NS	50/MLFT/NPI	50/MLFT/NP7	50/MLFT/NE
	54	54	54	54	54	54	54
	81	81	81	81	81	81	81
	-	-	-	-	-	-	-
	190	190	215	220	218	215	239
code	5048		5011		4814		
ITEM	50/MLFT/NdB8	50/MLFT/NdB10	50/MLFT/NdF	50/MLFT/NdS	50/MLFT/NdPI	50/MLFT/NdP7	50/MLFT/NdE
	54	54	54	54	54	54	54
	81	81	81	81	81	81	81
	-	-	-	-	-	-	-
	-	-	-	-	-	-	-
code	5213				5053		

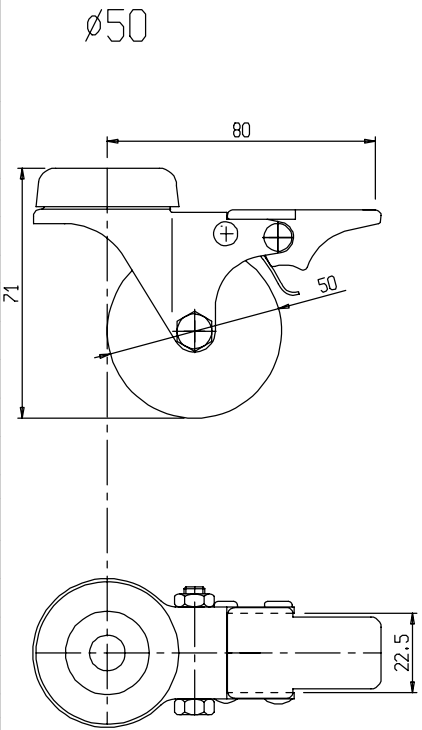



ITEM	50/MLFT/G-Gd-SR-SRd	ITEM	50/MLFT/N-Nd	ITEM	50/MLFT/G-Gd-Gc
	con Asse Rivettato With riveted axle		con Asse a Vite With screw axle		Nucleo Grigio Grey Centre

# Compressivi girevoli Serie 60 MLFT nelle varie tipologie di: Fissaggi, Ruote assemblati Swivel castors of the 60 MLFT series with different types of fixings, assembled wheels















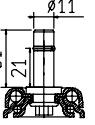
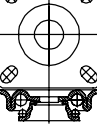
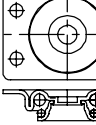
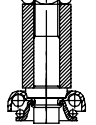
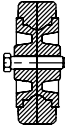



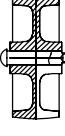

Requisiti dei Compressivi assemblati alle varie Ruote  
Requirements of the castors assembled with the different wheels

\* Gli articoli evidenziati in colore verde sono in fase di allestimento.  
\* Articles written in green colour are in course of preparation.

Portata Dinamica conforme UNI EN 12527  
Dynamic load capacity conform UNI EN 12527 

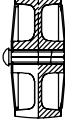
Portata Statica conforme UNI EN 12527  
Static load capacity conform UNI EN 12527 

Resistenza Passiva del Dispositivo Frenante, conforme UNI EN 12527  
Passive resistance of braking device in compliance UNI EN 12527 

		B8	B10	F	S	PI	P7 68.5x48	E
 = Peso per 1 pezzo  = Weight for a piece								
	ITEM	60/MLFT/GB8	60/MLFT/GB10	60/MLFT/GF	60/MLFT/GS	60/MLFT/GPI	60/MLFT/GP7	60/MLFT/GE
		38	38	38	38	38	38	38
		57	57	57	57	57	57	57
		-						
		244	244	269	274	272	269	293
code		5018			5019			
	ITEM	60/MLFT/NB8	60/MLFT/NB10	60/MLFT/NF	60/MLFT/NS	60/MLFT/NPI	60/MLFT/NP7	60/MLFT/NE
		58	58	58	58	58	58	58
		87	87	87	87	87	87	87
		-						
		209	209	234	239	248	245	258
code			5061					
	ITEM	60/MLFT/NdB8	60/MLFT/NdB10	60/MLFT/NdF	60/MLFT/NdS	60/MLFT/NdPI	60/MLFT/NdP7	60/MLFT/NdE
		58	58	58	58	58	58	58
		87	87	87	87	87	87	87
		-	231	256	261	270	267	280
	code							
	ITEM	60/MLFT/NdRaB8	60/MLFT/NdRaB10	60/MLFT/NdRaF	60/MLFT/NdRaS	60/MLFT/NdRaPI	60/MLFT/NdRaP7	60/MLFT/NdRaE
		58	58	58	58	58	58	58
		87	87	87	87	87	87	87
		-	223	248	253	262	283	307
	code							

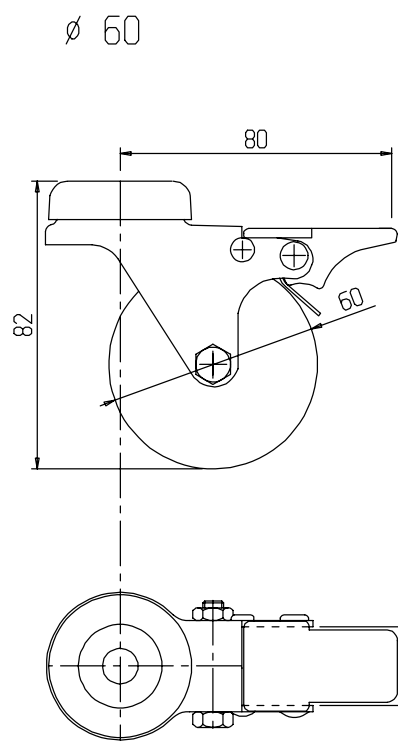

ITEM	60/MLFT/G	ITEM	60/MLFT/N-Nd-NdRa	ITEM	60/MLFT/G
	con Asse Rivettato With riveted axle		con Asse a Vite with screw axle		Nucleo Grigio Grey Centre